

ALUMINIUM AND GLASS

BALUSTRADES

FRAMED | SEMI-FRAMELESS | FRAMELESS BALUSTRADE SYSTEMS

 JURALCO®

BALUSTRADE SYSTEMS



WHAT IS A BALUSTRADE?

A balustrade is a safety barrier designed to prevent falls in areas with falls of 1+ metres, which are typically decks, balconies or stairways. Balustrades are a compulsory part of NZ building regulations and do an incredibly important job, keeping people safe from falling and hurting themselves when they are at heights.

ALL OF OUR BALUSTRADE SYSTEMS ARE COMPLIANT WITH NZ BUILDING REGULATIONS.

THINGS TO CONSIDER



OCCUPANCY TYPE

How is the space alongside the balustrade used? Is it one dwelling, or more than one, is there a risk of crowding?



BUILDING USAGE

Is the balustrade also a pool fence? This determines minimum barrier height.

- Residential - 1000mm
- Commercial - 1100mm
- Pool Fencing - 1200mm



HEIGHT

Minimum heights are dependent on **Building Usage**, but extra height may be requested for reasons such as privacy or windbreaks, or for practical requirements (eg balustrades on a floating deck).



WIND PRESSURE

Balustrade systems are designed and tested to a wind pressure. If you know your wind pressure or wind speed for your site, then it could save you money. Wind zone can be used to determine compliance for simple structures.



CUSTOM MADE

Our balustrade experts have an intimate knowledge of all our systems and will pick and customise the best solution for your situation, reducing costs and improving aesthetics.



STYLE

We have a wide range of styles which are updated to reflect modern trends. From traditional to modern designs, with a limitless colour selection available.



COST

All our balustrades have been designed with efficiency and cost in mind. Our experts will run you through your options and choose the right solution for your situation.



MAINTENANCE

We use high quality, low maintenance materials such as glass & powder coated aluminium, so with minimal upkeep you know your balustrade will remain colourful, straight and safe for years to come.



ACCESSORIES

Accessories can increase the scope of use or improve the balustrade look.

Powder coated in NZ using the best in Dulux® powder coating technology.

CONTEMPORARY & HOMESTEAD® BALUSTRADE

VIKING® BALUSTER

EDGE® BALUSTER

PREFABRICATED ALUMINIUM BALUSTER PANELS

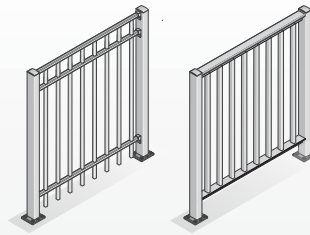

LOW

FRAMED ALUMINIUM BALUSTER

17mm baluster with top and bottom rail

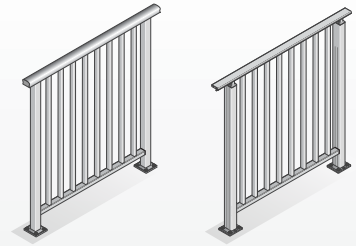

LOW

EDGE® LAMERRA

EDGE® SLAT

EDGE® FIN

VIKING® BALUSTRADE

EDGE® BALUSTRADE

FRAMED ALUMINIUM SCREENING, SLAT & FIN

Perforated screen panels, slats or 49mm fins

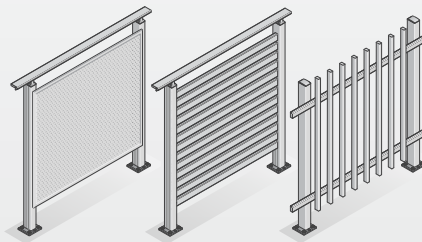

MEDIUM

FRAMED GLASS

6mm, 8mm or 10mm toughened glass with top and bottom rail

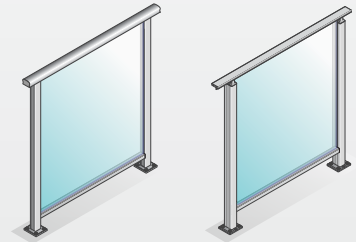

LOW

VIKING® BALUSTRADE

EDGE® BALUSTRADE

EDGE® BALUSTRADE

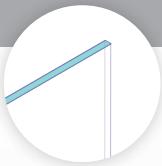

SEMI-FRAMELESS GLASS WITH HANDRAIL

8mm or 10mm toughened glass with interlinking or structural handrails

LOW

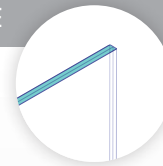
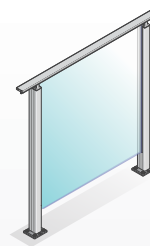
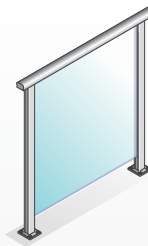

WITHOUT HANDRAIL

13.2mm laminated glass without handrail

MEDIUM/HIGH

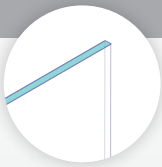
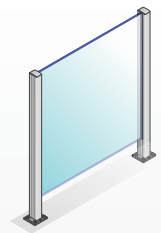

FRAMELESS GLASS WITH HANDRAIL*

12mm or 15mm toughened glass with interlinking top rail

MEDIUM/HIGH

EDGETEC® MINI POST

EDGETEC® INFINITY

EDGETEC® JH CLAMP

EDGETEC® DOUBLE DISC

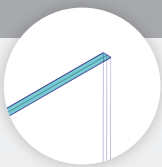
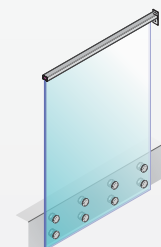
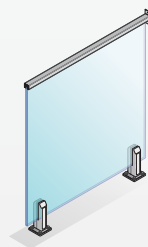

FRAMELESS GLASS WITHOUT HANDRAIL

15.2mm or 17.22mm laminated glass and clamps, 13.52mm or 17.52mm Sentry Laminated glass

HIGH

EDGETEC® DOUBLE DISC

EDGETEC® INFINITY

EDGETEC® DOUBLE DISC

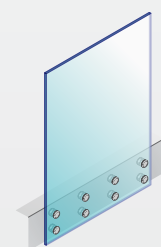
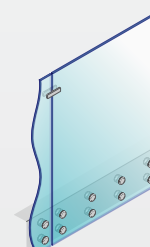

*To meet NZS4223.3.2016 requirements



VIKING® BALUSTRADE SYSTEM

ALUMINIUM POST SYSTEM WITH BALUSTER/ GLASS

Relied on for safety and style in NZ homes, for over 20 years.

Viking is one of the original aluminium post balustrade systems for rail or glass finishes, providing dependable safety and style in NZ homes for over 20 years.

- Occupancy Types A, A Other & C3 Residential
- Suitable for Pool Fencing (fully compliant)
- Split rail finish available for balusters/glass
- Aluminium infill: Baluster or slat
- Glass infill: Toughened Safety Glass 6mm & 10mm
- Suitable for waterproof/floating decks
- Five handrail styles





EDGE® BALUSTRADE SYSTEM

ALUMINIUM POST SYSTEM WITH BALUSTER/ SLAT/LOUVRE/GLASS

The Edge® Balustrade System is a versatile solution for safety barriers on decks, stairways, balconies, handrails or as pool fencing. The system can incorporate glass panels, or a variety of aluminium infills within a fully framed, semi frameless or split rail layout. It has been developed to offer a great deal of choice to the customer and comes with a variety of accessories such as hidden fix posts, to hide it's fixings and gutter brackets, so it can be used on waterproof decks.

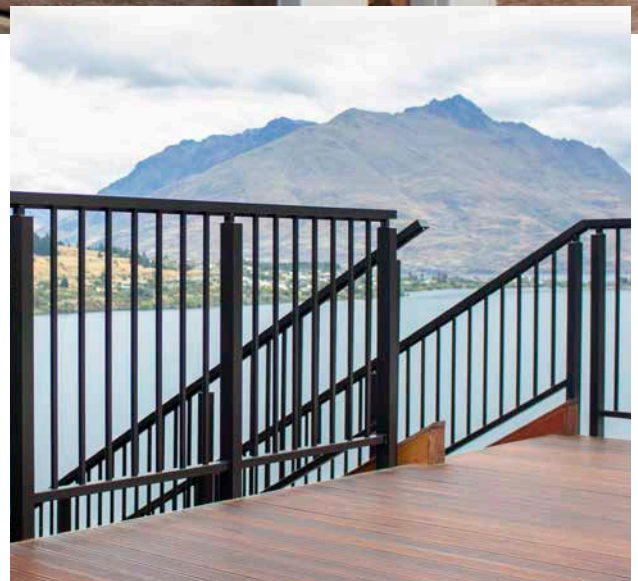

- Occupancy Types A, A Other & C3 Residential
- Suitable for Pool Fencing (fully compliant)
- Split rail finish available for aluminium infill/glass
- Aluminium infill: Baluster, slat, louvre, perforated sheet and fin
- Glass Infill: Toughened Safety Glass 6mm, 8mm & 10mm.
Toughened laminated glass 13.2mm
- Suitable for waterproof/floating decks
- Five handrail styles

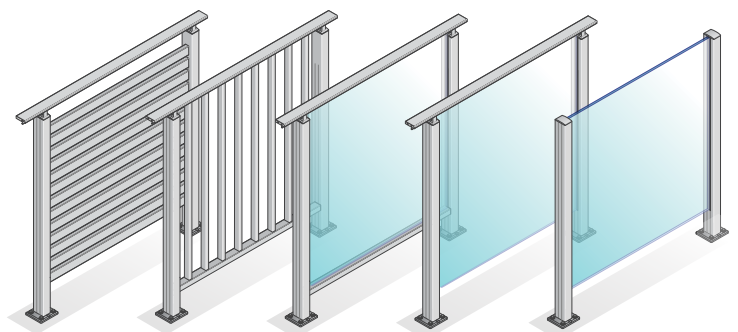



EDGE® STECCA™ BALUSTRADE

ALUMINIUM POST SYSTEM WITH FRONT MOUNTED SLAT (FIN)

Edge® Stecca™ has been developed for modern designs where aluminium detailing is front and centre of the building look.

Fitting slats to the front of the balustrade support rails (rather than inside the rails), adds an extra dimension of depth and greater choice for homeowners and designers. Stecca™ offers all the great Edge balustrade features that you know and love, including custom powder coating in a colour your choice.

- Occupancy Types A, A Other & C3 Residential
- Suitable for Pool Fencing (fully compliant)
- Aluminium infill: Slat (fin) front mounted
- Suitable for waterproof/floating decks
- Aluminium caps for slats & post ends
- Optional handrail fixed to inside

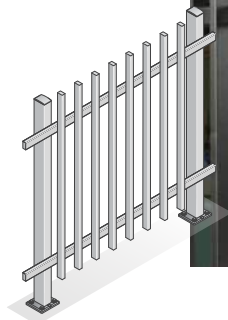



EDGE® LAMERRA™ BALUSTRADE

ALUMINIUM POST SYSTEM WITH SCREEN SHEET

Edge® Lamerra™ features a perforated aluminium screen which is a low maintenance, robust finish which fully embraces modern design principles such as the popular industrial look. Especially favoured for their unique design features, perforated (punched) screens keep the view clear with a semi-translucent finish, whilst a solid looking finish creates privacy when viewed from the outside.

Choose from two finishing styles: Screen edges capped in a black or white band, or an exposed fixing option.

- Occupancy Types A, A Other & C3 Residential
- Aluminium infill: Punched sheet
- Suitable for Waterproof/Floating Decks
- Five Handrail Styles
- Edge Capping: Black or White

Mesh style - Proprietary perforated 1.6mm hardened aluminium sheet

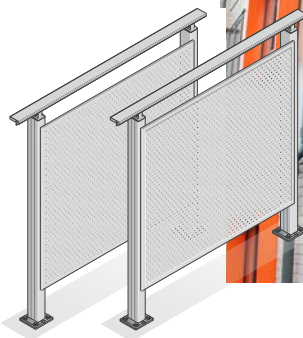
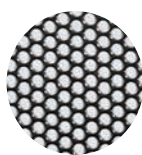



EDGETEC® COMMERCIAL POST BALUSTRADE

ALUMINIUM POST SYSTEM WITH BALUSTER/ GLASS (COMMERCIAL GRADE)

Commercial balustrades are heavy duty barrier systems designed for more stringent performance demands, such as a minimum height requirement of 1100mm (above deck) vs 1000mm for a residential balustrade. Edgetec Commercial Post offers all the same great benefits as the residential systems, including a choice of semi-frameless or framed glass styles and powder coated, in a colour of your choice.

- Occupancy Types A, B, E, C, C1, C2, C3 & D (not C5)
- Split rail finish available for aluminium infill/glass
- Aluminium infill: Baluster or slat
- Glass Infill: Toughened Safety Glass 8mm, 10mm, 12mm or 15mm
- Five handrail styles





EDGETEC® MINI POST BALUSTRADE

ALUMINIUM STRUT POST FOR GLASS

Edgetec® Mini Post is an attractive, strut post balustrade system designed for 12mm toughened safety glass panels, to give a frameless glass finish. Slim interlinking top rails powder coated in a colour matching the Mini Posts, are required as backup in the unlikely event of the glass breaking.

- Occupancy Types A, A Other & C3 Residential
- Suitable for Pool Fencing (fully compliant)
- Interlinking top rail - round or rectangular style
- Suitable for waterproof/floating decks
- Glass options – 12mm toughened safety glass only





EDGETEC® JH CLAMP BALUSTRADE

ALUMINIUM CLAMP FIXING FOR GLASS

Edgetec® JH Clamp is a rectangular balustrade bracket for 12mm or 15mm toughened glass panels, finished with either round or rectangular interlinking top rails. Manufactured from architectural grade aluminium, JH Clamp is a popular alternative to the traditional round anchor balustrades, particularly for the wider fixing centres (up to 50% more), resulting in a less visual impact. Powder coated in a range of modern colours, JH Clamp is a popular option for its minimalist frameless glass style.

- Occupancy Types A, A Other, C3 Residential & C3 Commercial
- Suitable for Pool Fencing (fully compliant)
- Interlinking top rail - round or rectangular style
- Hidden fixing option for timber deck - conceals JH Clamp
- Glass options 12mm or 15mm toughened safety glass





EDGETEC® INFINITY BALUSTRADE

ALUMINIUM CHANNEL SYSTEM FOR GLASS

Edgetec® Infinity™ is a continuous channel type balustrade for toughened, laminated or Sentry laminated glass panels, creating a frameless glass finish. Popular for its linear finish, Infinity balustrade uses proprietary clamps to fix glass panels, without the need for holes in the glass. Clamps are set at regular centres and aligned via a continuous back plate and have been designed to accommodate a range of glass types for greater customer choice in frameless glass finishes.

- Occupancy Types A, A Other, B, E, C3 Residential & C3 Commercial
- Suitable for Pool Fencing (fully compliant)
- Interlinking top rail - round or rectangular style
- Glass options – 12mm or 15mm toughened safety glass, 13.52mm or 17.52mm SentryGlas
- Hidden fixing option available
- Face fix or top fix options





EDGETEC® DOUBLE DISC ANCHOR CLAMP BALUSTRADE

ALUMINIUM/STAINLESS STEEL DISC FOR GLASS

Edgetec® Double Disc Anchor is a 50mm diameter traditional style disc for a range of toughened, laminated and Sentry laminated glass panels in a frameless glass finish.

Aluminium Double Discs are made from an architectural grade aluminium and finished in a powder coat colour of your choice.

Stainless Steel Discs are made from solid 316 marine grade SS and are available in a polished or satin finish.

- Occupancy Types A, A Other, B, E, C3 Residential & C3 Commercial
- Suitable for Pool Fencing (fully compliant)
- Interlinking top rail - round or rectangular style
- Glass options – 12mm or 15mm toughened safety glass, 15.2mm or 17.2mm laminated glass and 13.52mm or 17.52mm SentryGlas
- Laminated glass fixing clamps available
- Hidden fixing option available
- 50mm

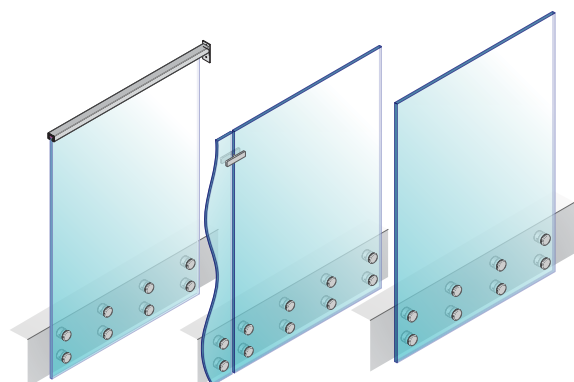



EDGETEC® SINGLE DISC ANCHOR CLAMP BALUSTRADE

ALUMINIUM/STAINLESS STEEL DISC FOR GLASS

Edgetec® Single Disc Anchor is a 75mm diameter disc for toughened glass panels in a frameless glass finish.

Aluminium Single Discs are made from an architectural grade aluminium with hidden fixing and finished in a powder coat colour of your choice. Stainless Steel Discs are made from solid 316 marine grade SS and are available in a satin finish with a visible fixing screw.

- Occupancy Types A, A Other, B, E, C3 Residential & C3 Commercial
- Suitable for Pool Fencing (fully compliant)
- Interlinking top rail - round or rectangular style
- Glass options – 12mm or 15mm toughened safety glass
- Hidden fixing option available
- 75mm

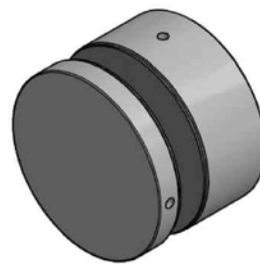
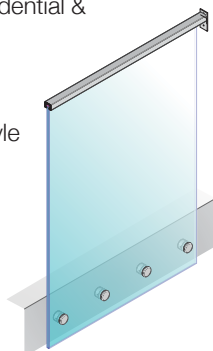

Hidden Fix Type
Powder Coated Aluminium
75mm

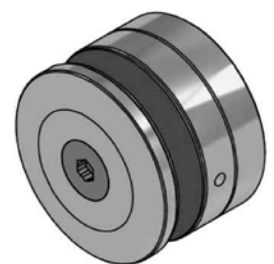

Visible Screw Fix Type
316 Stainless Steel Satin Finish
75mm



HOMESTEAD® AND CONTEMPORARY BALUSTRADE

PREFABRICATED ALUMINIUM PANELS

Homestead is a baluster panel system which is ideal for residential situations where a strong, entry level aluminium balustrade is required. Prefabricated panels are 1360mm wide x 975mm high, fixed to a post, raked panels can be used on a slope up to 35° making it suitable for stairs. Maximum height 1000mm.

Contemporary is a premade welded or riveted baluster panel system for outdoor applications (such as retaining walls), where a balustrade is required. Suitable for residential applications only, riveted Contemporary balustrades can be used on an angle up to 11.5° (raked). Maximum height 1275mm.

- Occupancy Types A, A Other & C3 Residential
- Suitable for waterproof/floating decks
- Contemporary only: Suitable for Pool Fencing (fully compliant)





ALUMINIUM RAILS

Handrails are an integral safety feature for balustrades, especially on stairways. They are most commonly fitted as a top rail which doubles as a frame on aluminium post balustrades, or as a standalone handrail fitted on posts or stairway walls. Frameless Glass Balustrades (using standard toughened glass), require an interlinking top rail, which would serve as a safety rail if the glass broke.

Note: Specialised laminated glass panels not requiring top rails are also available.

ALUMINIUM POST BALUSTRADE

VIKING®

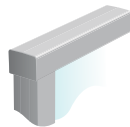

Rectangular Handrail

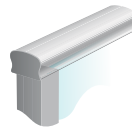

Classic Handrail

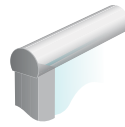

Semi-circular Handrail

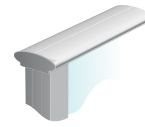

Elliptical Handrail

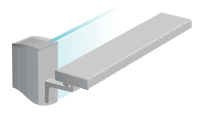

Interlinking Rail

EDGE®

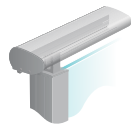

Aerofoil Handrail

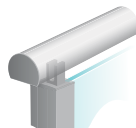

Semi-circular Handrail

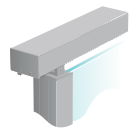

Rectangular Handrail

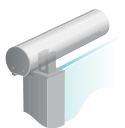

Circular Handrail

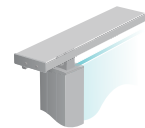

Interlinking Rail

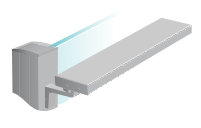

Interlinking Rail Front Mounted on Brackets

FRAMELESS GLASS BALUSTRADE

EDGETEC®



Round Interlinking Top Rail

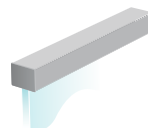

Square Interlinking Top Rail

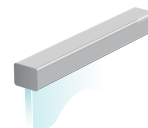

Stainless Steel Interlinking Top Rail

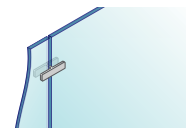

Glass Support Bracket

GUTTER BRACKET

An aluminium bracket designed especially for floating/waterproof decks which fits the balustrade post on the bracket top and guttering underneath. Gutter Brackets have been designed for easy attachment of standard NZ gutter systems. Available on Homestead®, Viking®, Edge® and Edgetec® Mini Post balustrade systems.

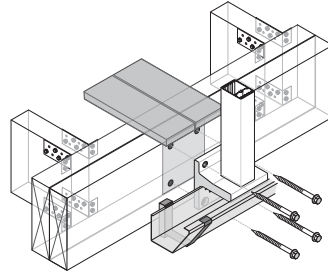

GLASS POOL GATES

Matching glass pool fencing gates are possible with these specially designed hydraulic hinges and self-closing latches. Available for either 10mm or 12mm toughened glass panels, in a range of options for connecting to either glass or aluminium post pool fencing systems.

Glass gate hinges and latches are manufactured from top quality Stainless Steel, with an option for aluminium hinge covers allowing for powder coating in a colour to match the surrounding joinery.



LAMINATED GLASS PROTECTION CAPS

Recommended to protect glass edges on laminated panels.



INTERLINKING TOP RAIL CONNECTORS*

HORIZONTAL 90°FIXED CONNECTOR

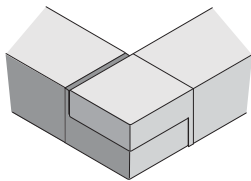

Aluminium

VERTICAL ADJUSTABLE CONNECTOR

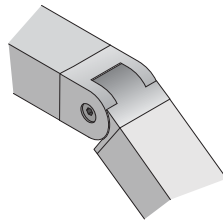

35°Up or Down Aluminium



*Ask your balustrade installer for details on the complete range of connector products

To guarantee customer satisfaction and ensure a high standard of quality, Juralco balustrades are only available from the most highly qualified tradesman who have been certified to install these balustrade systems. You can refer to the address here and be confident that you will have a service that matches the Juralco balustrade product quality.

JURALCO®
BALUSTRADE SYSTEMS

www.juralcobalustrades.co.nz

Authorised Installer: